

<p>1</p>  <p>Place tile on a clean and flat surface (white side down), then gently fold in half.</p>	<p>2</p>  <p>Carefully fold side flap as shown to prevent wrinkling or damage to tile.</p>	<p>3</p>  <p>Repeat step 2 on other side to fold side flap.</p>	<p>4</p>  <p>Gently fold as shown to bring tab to slot and give tile dimension.</p>
<p>5</p>  <p>Insert tab into the edge slot.</p>	<p>6</p>  <p>Secure tab by inserting into the second slot and fold over edge.</p>	<p>7</p>  <p>Gently fold inward to release tension in the creases. This will allow the tile to sit flat in the drop ceiling grid.</p>	<p>8</p>  <p>Fold edge over on all four sides.</p>

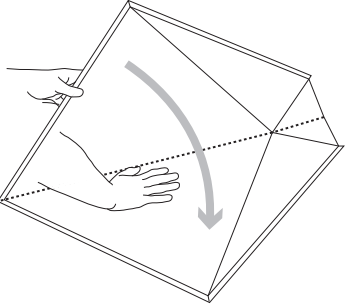

Tile is ready to install!

**MIOCULTURE.COM**

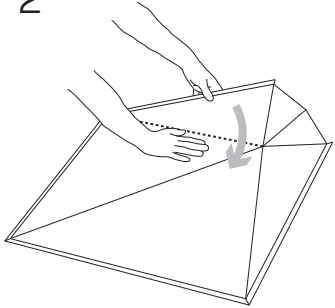
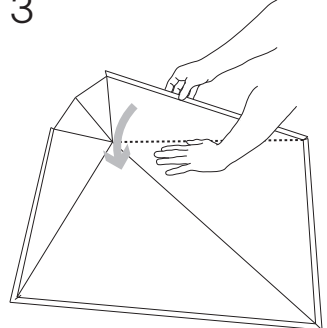
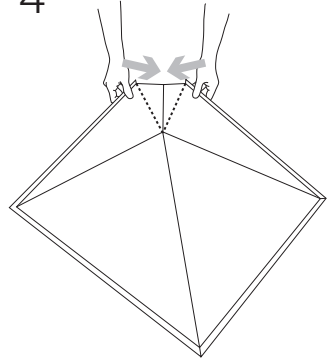
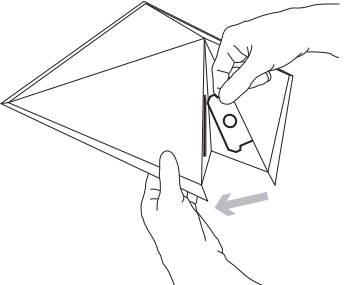
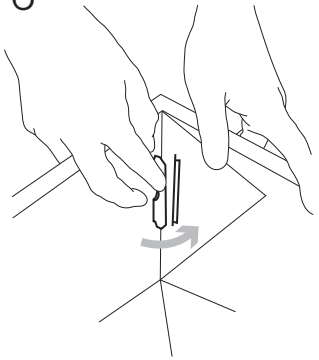
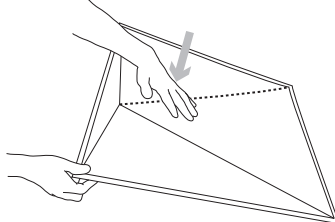
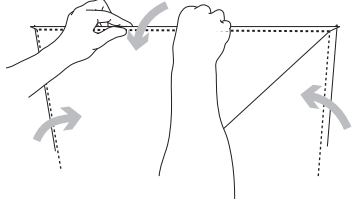
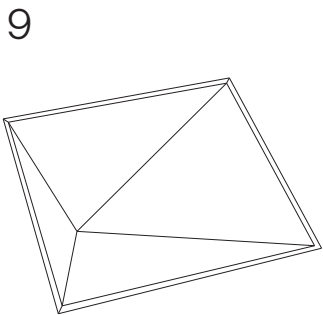

All trademarks, service marks and trade names (MIO, product names and the MIO logo) are owned and registered by MIO. All content including but not limited to text, designs, graphics, photos and all other content ("Content") is a collective work under the United States and other copyright laws and is the proprietary property of MIO. All rights reserved. ©2025 MIOOIM LLC

Still have questions?  
Drop us a line or give us a call:

Email: [info@mioculture.com](mailto:info@mioculture.com)  
US Toll Free: 1 - 888 - 563 - 3916  
International: +1 (215) 925 - 9359