

Parts List + Surface Preparation

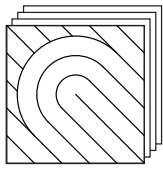

4 ACOUSTIC TILES

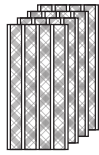

16 ADHESIVE STRIPS
(shipped upon request)

Prepare installation surface by cleaning it thoroughly and making sure it is flat and even.

1

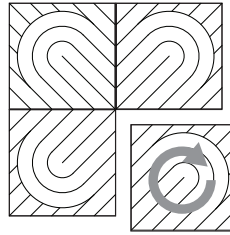

Select a pattern for installation. Test the arrangement on a clean surface. We recommend having a printed layout to reference during installation.

2

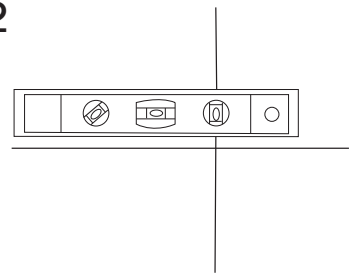

Use a level or a laser to mark where the first tiles will be placed.

Double-sided Tape Installation

3

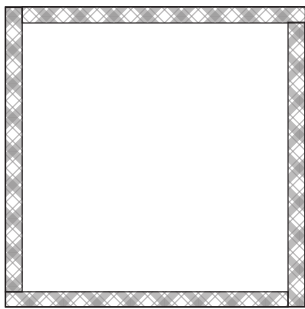

Apply adhesive strips as shown so that each corner is covered with tape.

4

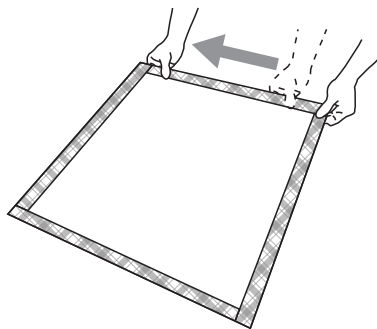

Press firmly along the entire perimeter to ensure tape is secure. Use a roller if available.

5

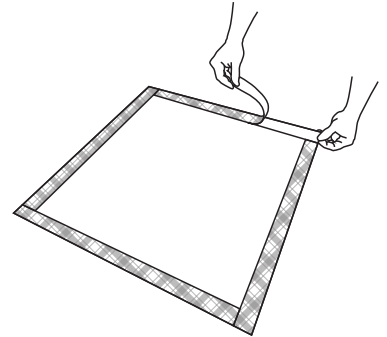

Peel backing off of each strip and apply tile to wall butting tile edges.

Construction Adhesive Installation

3

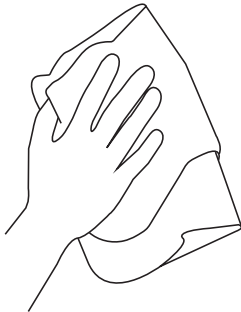

Wipe wall with a damp cloth for faster adhesive set times. It is recommended to sand installation surfaces that are too slick.

4

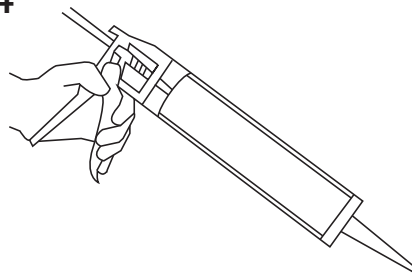

Apply Fuze*It All Surface Adhesive to the back of each tile. Apply adhesive one tile at a time to avoid drying before wall application.

5

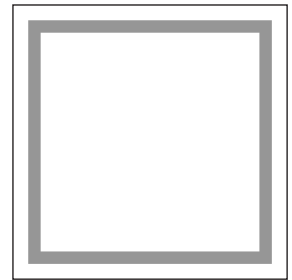

Apply a 1/4 inch adhesive bead to tile perimeter. Apply at least 1/4 in away from edge to prevent adhesive squeeze-out. Carefully remove and clean excess adhesive.

Final Step

6

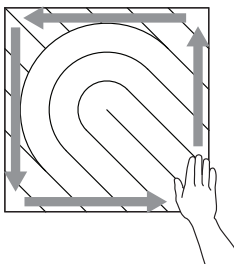

Once tiles are applied to wall, press firmly along each edge **repeatedly** until the tile is securely adhered. Carefully remove excess adhesive.

Cutting & Trimming Tiles

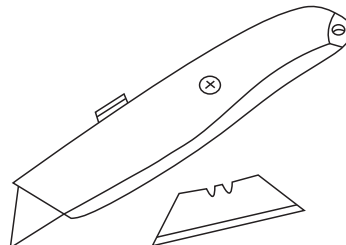

Tiles can be cut using a sharp utility knife and new blades or power tools with blades for cutting plastic.

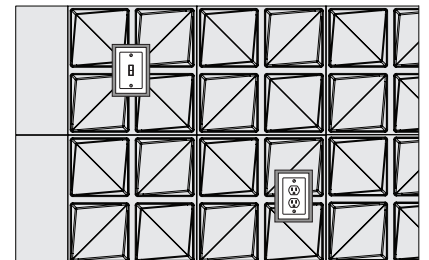

Install cut or Edge tiles where trim is least visible. Use wood trim around outlets, light switches, and mechanicals.

Ceiling Installation

1

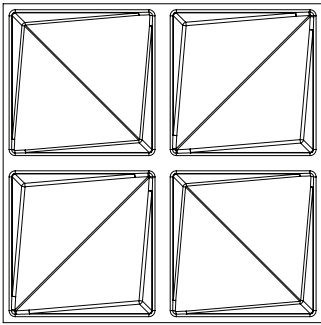

Unpack the product carefully and inspect for quantity and transportation damage. Keep product in a clean and dust free environment.

Important! These tiles are designed to work with standard 15/16 inch exposed tee commercial ceiling suspension systems.

2

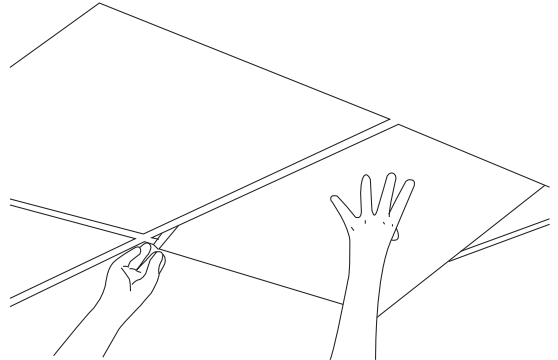

If replacing old ceiling tiles, remove the tiles and ensure the grid is clean, secure and square.

3

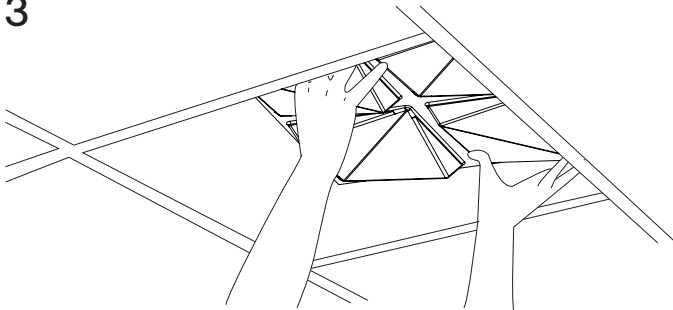

Tilt tiles at an angle to insert into ceiling grid. Position the tile perimeter so it sits flat on the grid. Tiles on the edges can be cut with a sharp utility knife or power tools. Mark with masking tape for accuracy.

4

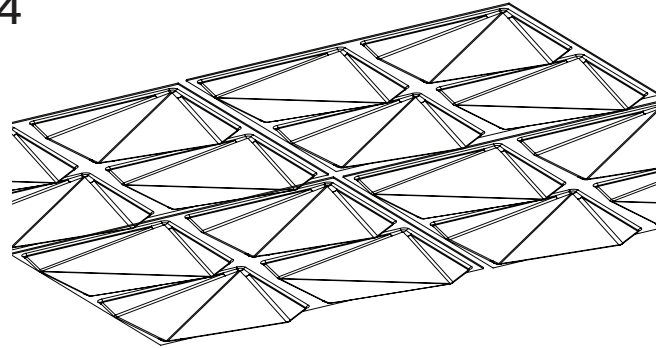

For complex cuts or room edges use our Edge ceiling tiles.

MIOCULTURE.COM



Still have questions?
Drop us a line or give us a call:

Email: info@mioculture.com
US Toll Free: 1 - 888 - 563 - 3916
International: +1 (215) 925 - 9359

All trademarks, service marks and trade names (MIO, product names and the MIO logo) are owned and registered by MIO. All content including but not limited to text, designs, graphics, photos and all other content ("Content") is a collective work under the United States and other copyright laws and is the proprietary property of MIO. All rights reserved.
©2025 MIOIIM LLC